

### Beautifloor kokos, Norwich, Leeds en Oxford matten

1) Controleer de ondervloer. Zorg dat deze druk- en trekvast, scheurvrij, schoon, vlak en droog is. (restvocht max. 2,5%).

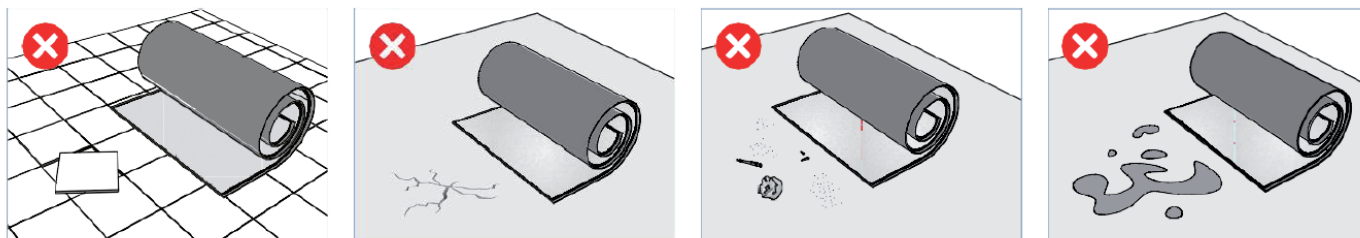

2) Gebruik rollen met hetzelfde batchnummer.

3) Acclimatiseer de mat voor 24 uur in een temperatuur van 15 - 25 graden.

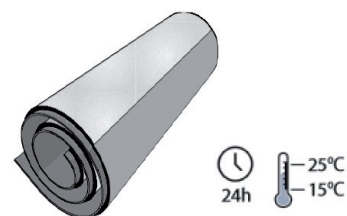

4) Zorg voor de juiste afwerking bij de randen.

- Bij A en B: verwijder de rand
- Bij C: behoud de rand

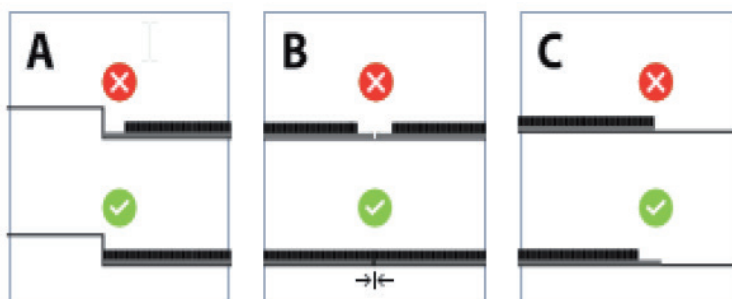
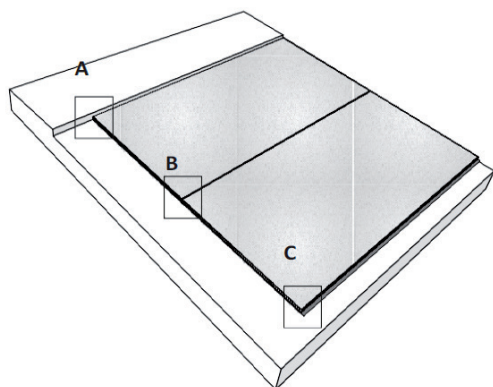

5) Voorkom naden in het looppad. Twee naden aan de zijkanten geeft de mat een langere levensduur dan één naad in het midden van de mat.

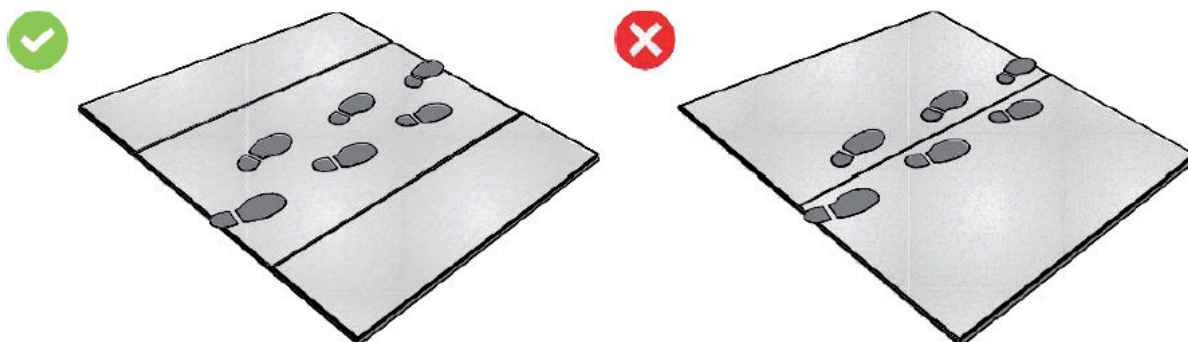

6) Leg de banen in dezelfde looprichting.

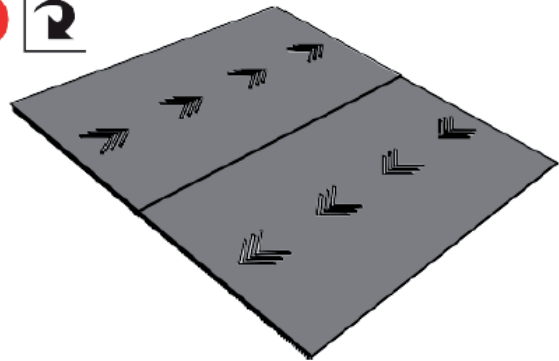
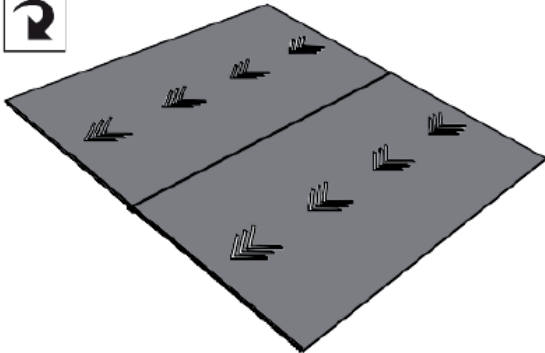

7) Snij altijd vanaf de achterzijde.

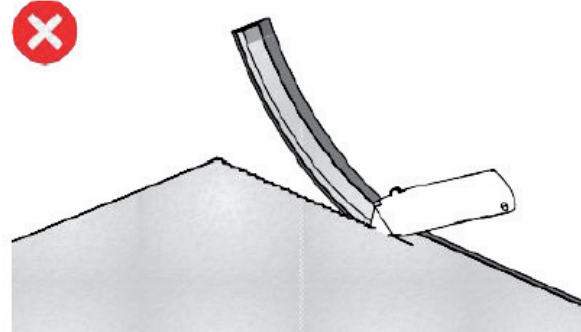
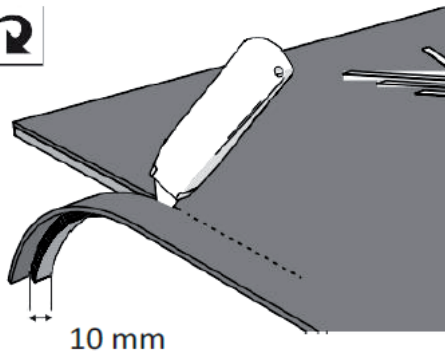

8) Omkrollende randen terugduwen om de randen spanningsloos te maken.

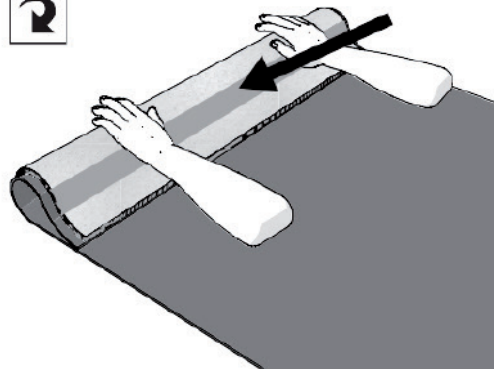
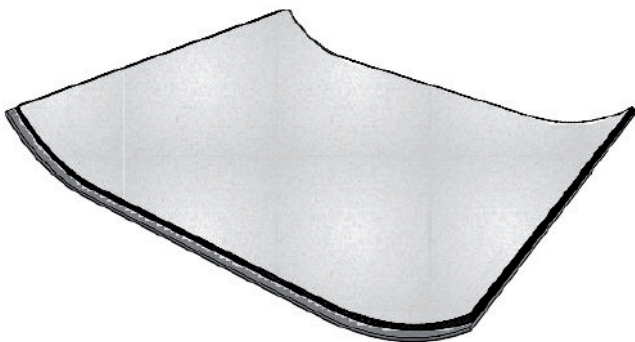

9) Gebruik de op de verpakking voorgeschreven lijm en lijmkam. Entreematten >6m<sup>2</sup> altijd verlijmen. Gebruik een volwaardige vinyllijm, geen fixeerlijm of antislip of gelijkwaardig.

